

DP 4K Video + USB 3-2-1 Arbutus™ 63301

1-Port USB-C 4K and USB 3.2, 100m CAT 6a
Extender System



Thank you for purchasing the Icron DP 4K Video + USB 3-2-1 Arbutus 63301.

Please read this user guide thoroughly.

FCC Radio Frequency Interference Statement Warning

This device complies with part 15 of the FCC Rules. Operation is subject to the following two conditions: (1) this device may not cause harmful interference, and (2) this device must accept any interference received including interference that may cause undesired operation.

CE Statement

We, SyncBridge Technologies Corporation, declare under our sole responsibility that the Icron DP 4K Video + USB 3-2-1 Arbutus 63301, to which this declaration relates, is in conformity with European Standards EN 55032, EN 55035, EMC Directive: 2014/30/EU, EN 62368-1, RoHS Directive 2011/65/EU + 2015/863/EU, EMC Directive 2014/30/EU, LVD Directive 2014/35/EU, and ErP Directive 2009/125/EC.

Industry Canada Statement

This Class A digital apparatus complies with Canadian ICES-003. CAN ICES-3 (A) / NMB-3 (A)

WEEE Statement

The European Union has established regulations for the collection and recycling of all waste electrical and electronic equipment (WEEE). Implementation of WEEE regulations may vary slightly by individual EU member states. Please check with your local and state government guidelines for safe disposal and recycling or contact your national WEEE recycling agency for more information.

Product Operation and Storage

Please read and follow all instructions provided with this product and operate it for intended use only. Do not attempt to open the product casing as this may cause damage and will void the warranty. Use only the power supply provided with this product. When not in use, this product should be stored in a dry location between -20°C and 70°C.



Table of Contents

Introduction	4
Product Contents	4
Features	4
Quick Start Guide	5
The LEX Unit	6
The REX Unit	7
Installation Guide	8
Arbutus Series Category Cabling Guidelines	8
Installing the Arbutus 63301	8
Requirements	8
Preparing Your Site	8
Installing the LEX Unit	9
Installing the REX Unit	9
Connecting the LEX to the REX	9
Checking the Installation	10
Connecting a USB/Video Device	10
Compatibility	10
Extender Mounting Options	11
Option 1: Extender Mounting Kit	11
Option 2: Extender Direct Surface Mounting	12
Direct Surface Mounting Measurement Stencil	12
Troubleshooting	13
Specifications	17
Warranty Information	18
Limited Hardware Warranty	18
Hardware Remedies	18
Limitation of Liability	18
Obtaining Warranty Service	18
Contacting Technical Support	19
Technical Glossary	20

Introduction

This guide provides product information for the Arbutus 63301, installation instructions and troubleshooting guidelines. The instructions in this guide assume a general knowledge of computer installation procedures, familiarity with cabling requirements and some understanding of USB-C devices.

NOTE: Notes provide additional useful information.

CAUTION: Cautions provide important information about an operational requirement.

Product Contents

Your Arbutus 63301 extender system contains:

- Arbutus 63301 LEX (Local Extender)
- Arbutus 63301 REX (Remote Extender)
- 5V DC 5A Power Adapter
- 5V DC 3A Power Adapter
- 2x Country Specific Power Cords
- Warranty and Compliance Insert

Features

The Arbutus 63301 incorporates ExtremeUSB® technology, enabling users to extend 4K video (DisplayPort Alt mode) and USB 3-2-1 beyond the standard 1m cable limit for USB-C peripheral devices. This extender system is composed of two units, the LEX and the REX, with the following key features:

- DP Alt mode up to 4Kp60 4:4:4 at 2 lanes HBR3
- HDCP 2.2 support
- Extends all USB 3.2 Gen 1, 2.0 and 1.1 devices simultaneously with 4K video up to 100m over CAT 6a or better cabling
- The REX (Remote Extender) can power a single USB-C device up to 15W
- Supports all USB transaction types (Control, Bulk, Interrupt, ISO)
- Compatible with all major Unified Communications conferencing and applications
- TAA Compliant

The Arbutus 63301 includes the ExtremeUSB® suite of features:

- Transparent USB and video extension
- True plug and play; no software drivers required
- Works with all major operating systems; Windows®, macOS™, Linux® and ChromeOS™

Quick Start Guide

Before you get started, ensure that all the drivers required for your USB device(s) are installed.

- 1 Place extenders where desired and connect the CAT 6a cable to the Link ports (RJ45) on the LEX and REX.

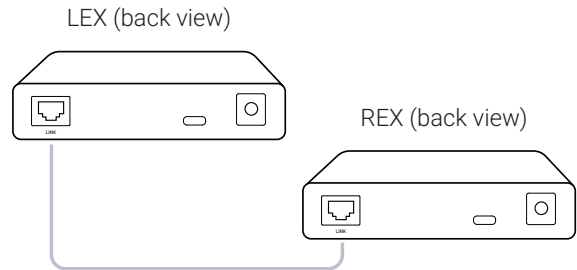

- 2 Power the LEX with the included 5V DC 3A adapter.

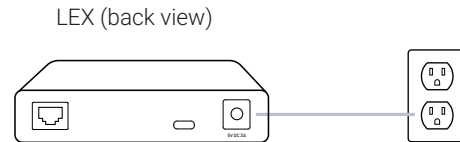

- 3 Connect the LEX to the computer using a USB 3 cable with a USB-C connector on one side, or both, depending on your port configuration.

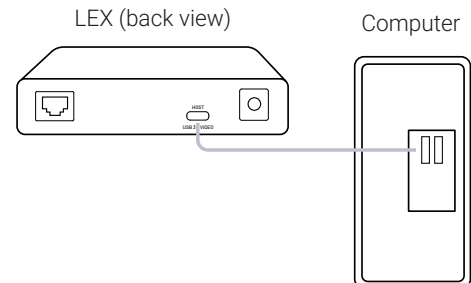

- 4 Power the REX with the included 5V DC 5A adapter.

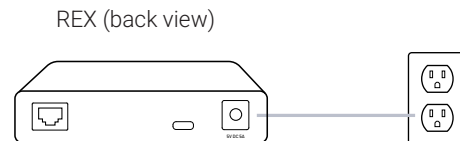

- 5 Attach USB device/monitor to the REX.

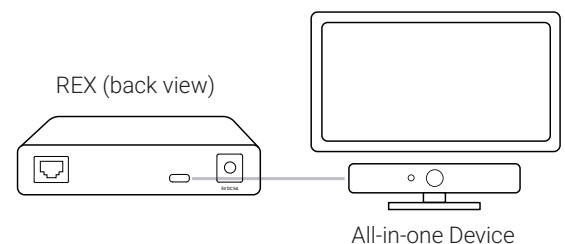

The LEX Unit

The LEX (Local Extender) unit connects to the host computer using a standard USB-C cable (not included). Alternatively, power for this unit can be provided by the included 5V 3A adapter.

Front Faceplate

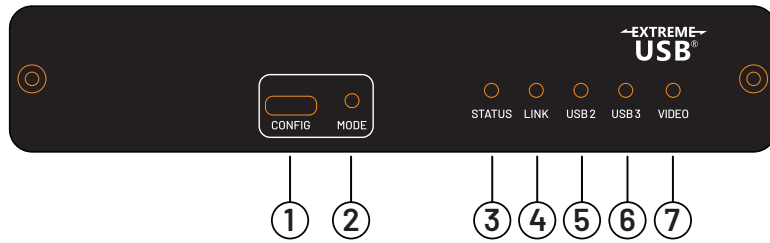

Back Faceplate



Item	Type	Description
1	Config	Reserved for manufacturer use.
2	Mode	Reserved for manufacturer use.
3	Status LED	LED is SOLID ON when system is functioning normally. LED BLINKS when system is booting or to indicate a temperature warning in unison with the LINK, USB 2, USB 3, and Video LEDs.
4	Link LED	LED is SOLID ON when LEX is linked to an opposite REX. LED is OFF when there is no connection between the LEX and REX units.
5	USB 2 LED	LED is SOLID ON when an active USB 2 connection is established through the extender system. LED BLINKS when the USB 2 connection is suspended/asleep. LED is OFF when no USB 2 connection is detected.
6	USB 3 LED	LED is SOLID ON when an active USB 3 connection is established through the extender system. LED BLINKS when the USB 3 connection is suspended/asleep. LED is OFF when no USB 3 connection is detected.
7	Video LED	LED is SOLID ON when video is actively streaming across the extender. LED BLINKS when HDCP secure video is streaming across the extender. LED is OFF when no video is detected.
8	Link Port (RJ45)	Accepts RJ45 connector for CAT 6a cabling to connect the LEX to the REX.
9	USB Host Port	USB 3 and DP Alt Mode Type C receptacle used to connect LEX to the USB-C computer and video source.
10	DC Power Port	Connector for the included power adapter -- accepts 5V DC 3A.

The REX Unit

The REX (Remote Extender) unit provides a single USB 3.2 and DP Alt Mode Type C port for connecting standard USB-C devices. Up to 31 devices may be connected by attaching USB hubs to the REX. Powered by an external 5V DC 5A adapter, the REX supplies 3A at the USB-C port.

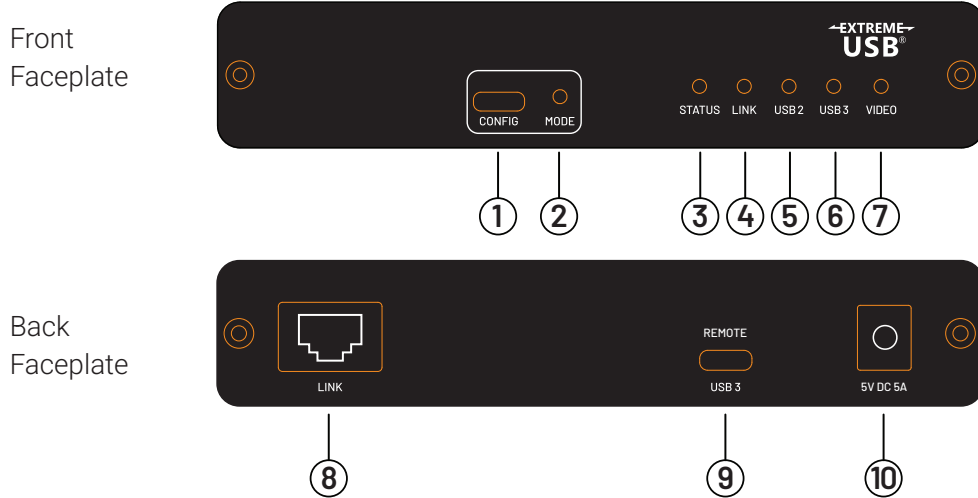

Item	Type	Description
1	Config	Reserved for manufacturer use.
2	Mode	Reserved for manufacturer use.
3	Status LED	LED is SOLID ON when system is functioning normally. LED BLINKS when system is booting or to indicate a temperature warning in unison with the LINK, USB 2, and USB 3, and Video LEDs.
4	Link LED	LED is SOLID ON when REX is linked to an opposite LEX. LED is OFF when there is no connection between the LEX and REX units.
5	USB 2 LED	LED is SOLID ON when an active USB 2 connection is established through the extender system. LED BLINKS when the USB 2 connection is suspended/asleep. LED is OFF when no USB 2 connection is detected.
6	USB 3 LED	LED is SOLID ON when an active USB 3 connection is established through the extender system. LED BLINKS when the USB 3 connection is suspended/asleep. LED is OFF when no USB 3 connection is detected.
7	Video LED	LED is SOLID ON when video is actively streaming across the extender. LED BLINKS when HDCP secure video is streaming across the extender. LED is OFF when no video is detected.
8	Link Port (RJ45)	Accepts RJ45 connector for CAT 6a cabling to connect the LEX to the REX.
9	Device Port (USB-C)	USB 3 and DP Alt Mode Type C receptacle used to connect REX to the USB and video devices.
10	DC Power Port	Connector for the included power adapter -- accepts 5V DC 5A.

Installation Guide

Arbutus 63301 Category Cabling Guidelines

The Arbutus 63301 requires a minimum grade of Category (CAT) 6a Unshielded Twisted Pair (UTP) cabling to be used in order to reach 100m (330 ft) of extension distance. CAT 7 and shielded cabling may be used but is not necessary.

NOTE: The total distance of 100m also includes the length of the patch cable should one be required. Up to 10m of patch cable can be used, although the remaining 90m distance must consist of solid core premise cabling.

Installing the Arbutus 63301

Requirements

To complete the installation, you will also require the following items that are not included with this system:

- USB-C compatible host computer with a USB compliant operating system and support for DP Alt mode
- USB compatible device(s)
- CAT 6a cabling with two information outlets and two CAT 6a patch cords with RJ45 connectors (if using premise cabling), ensuring the total cable length does not exceed 100m

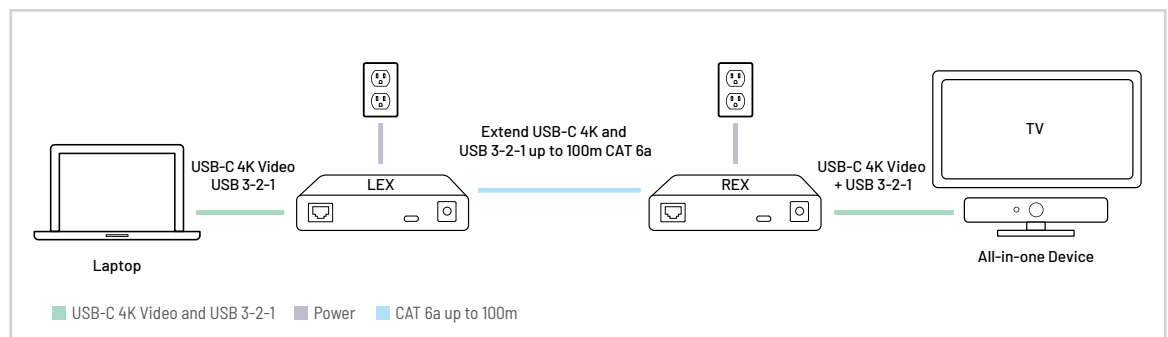

Preparing Your Site

Before installing this system, you will need to prepare your site:

1. Position your computer in the desired location and complete the setup.
2. Ensure to locate your USB and video device(s) within the 100m range of your CAT 6a cable.

NOTE: If you are using surface cabling, the Arbutus 63301 supports a maximum distance of 100m. Install the CAT 6a cabling as desired and terminate it with the appropriate RJ45 ends. If using premise cabling, (in-building network infrastructure), ensure your cabling is installed between the two locations and does not exceed 100m and that it meets CAT 6a specification.

CAUTION: Be sure to follow best practices for cable installation. For example, when terminating cables, ensure the matching RJ45 connector is used for the cable type. Otherwise, the benefits of using higher grade cabling may not be realized.

Installing the LEX Unit

1. Place the LEX unit near the computer.
2. Assemble the 5V 3A power adapter and country specific power cord together and connect them into a suitable AC outlet.
3. Connect a USB-C cable between the LEX host port and to a USB-C port on your host computer that supports USB 3 and DP Alt mode.

Installing the REX Unit

1. Place the REX near the USB/video device(s).
2. Assemble the 5V 5A power adapter and country specific power cord together and connect them into a suitable AC outlet.
3. Connect the power adapter to the REX.

Connecting the LEX to the REX

With Surface Cabling:

1. Plug one end of the CAT 6a cable (not included) into the Link port (outermost RJ45 connector) on the LEX.
2. Plug the other end of the CAT 6a cable into the Link port (outermost RJ45 connector) on the REX.

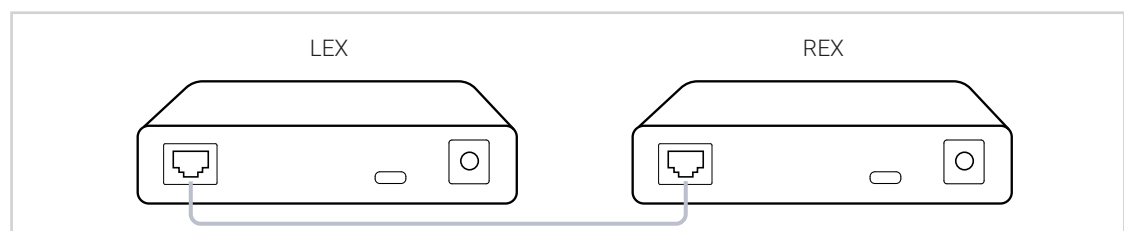

With Premise Cabling:

1. Plug one end of a CAT 6a patch cord (not included) into the Link port (RJ45 connector) on the LEX.
2. Plug the other end of the patch cord into the CAT 6a information outlet near the host computer.
3. Plug one end of the second CAT 6a patch cord (not included) into the Link port (RJ45 connector) on the REX.
4. Plug the other end of the patch cord into the CAT 6a information outlet near the USB-C device.

NOTE: Do not exceed more than 10m total of patch cable when using premise cabling.

Checking the Installation

1. On the LEX and REX units, check that the Status, Link, USB 2, USB 3 and Video LEDs are on. If the Link LEDs are permanently off, then the cabling between the LEX and REX units may not be installed properly or is defective.
2. If the Arbutus 63301 is not detected correctly or fails to detect, please consult the Troubleshooting section in this guide.

Connecting a USB/Video Device

1. Install any software required to operate your USB-C device(s). Refer to the documentation for the USB-C device(s), as required.
2. Connect the USB-C device to the device port on the REX.
3. Check that the device is detected and installed properly in the operating system.

Compatibility

The Arbutus 63301 complies with USB 2.0, USB 3.2 Gen 1 (5Gbps) and DisplayPort 1.4 specifications governing the design of video, USB and USB-C devices. However, there is no guarantee that all USB/video devices or hosts will be compatible as there are a number of different characteristics that may impact the operation of USB devices over extended distances.

Extender Mounting Options

The bottom of the Arbutus 63301 enclosures feature four convenient pre-drilled holes for optional mounting. Based on your requirements, choose from two available mounting options:

1. Extender Mounting Kit (purchased separately)
Order Part #10-00780-A01 Raven/Arbutus Mounting Kit - Black
2. Extender Direct Surface Mounting
(Use your own hardware and follow instructions listed on the next page)

Option 1: Extender Mounting Kit

Each 10-00780-A01 part includes:

- 2 mounting brackets
- 4 (M2.5x8mm) Philips raised cheese head screws with split locking washers
- Mounting bracket installation guide (pictured below)

NOTE: 1 kit required to mount LEX or REX unit, 2 kits per system.

Use a Phillips screwdriver to fasten and secure the mounting bracket into place using the provided screws as illustrated to the right.

Once both mounting brackets are secured onto the extender, it is ready for mounting onto a surface.

NOTE: You will need to provide your own screws to secure the extender onto the desired surface using the available slots on each bracket.

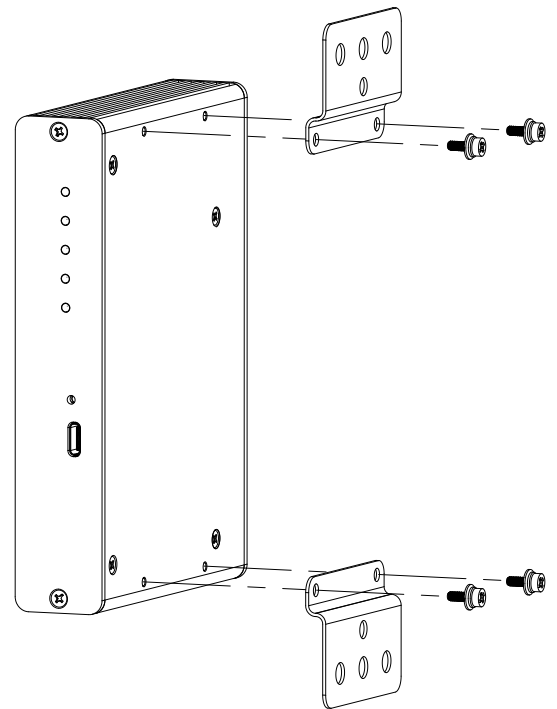

Option 2: Extender Direct Surface Mounting

Use your own hardware.

The bottom of the enclosure has four pre-drilled holes for surface mounting.
 Distance between the enclosure mounting holes:
 42.0mm x 124.5mm

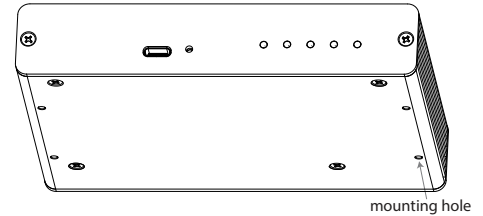

1. Mark the center point of each of the four holes on your mounting surface either by directly measuring or using this stencil.
2. Hardware recommendation: M2.5 locking washers and M2.5 screws (4 of each per extender) noting screw length will depend upon thickness of mounting surface.
3. Drill through each of the four hole markings on the mounting surface using a 3.70mm (0.1457") drill bit.
4. Align the bottom enclosure holes to the newly drilled out holes on the mounting surface.
5. Place a locking washer on each of the four screws and using a screwdriver, fasten the extender into place.

NOTES: Do not exceed a screw depth of 10mm (0.4") into the unit or damage may occur. To print this stencil to scale, either select the print dialogue box to "actual size" or set page scaling to "none".

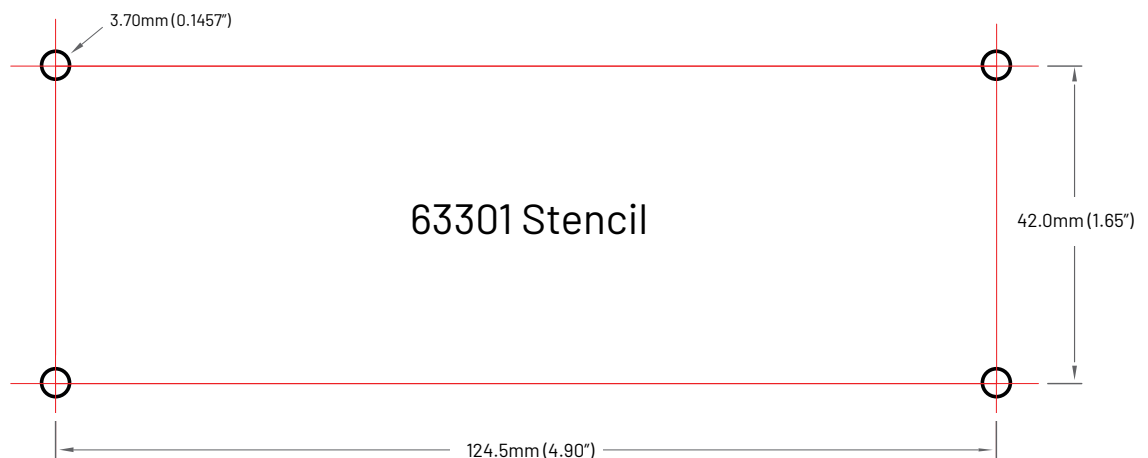

Troubleshooting

The following table provides troubleshooting tips. The topics are arranged in the order in which they should be executed in most situations. If you are unable to resolve the problems after following these instructions, please contact us at info@icron.com for assistance.

Problem	Cause	Solution
All the LEDs are OFF on the LEX and/or REX.	<p>The LEX is not receiving power from the host or receiving power from the AC adapter.</p> <p>The REX unit is not receiving power from the AC power adapter.</p>	<ol style="list-style-type: none"> 1. Ensure that the AC power adapter is properly connected to the LEX and/or REX. 2. Ensure the LEX is plugged into the host with a USB Cable. 3. Check that the AC adapter is properly connected to a live source of AC power. 4. Check if the LEX and/or REX Status LED is illuminated.
Status LED is OFF .	The unit has malfunctioned and requires re-programming.	<ol style="list-style-type: none"> 1. For assistance, contact info@icron.com.
Link LEDs on the LEX and the REX are OFF .	There is no connection between the LEX and REX units.	<ol style="list-style-type: none"> 1. Ensure no more than 100m of CAT 6a cabling is connected between the LEX and REX. 2. Connect a short patch cable between the LEX and REX. Recheck the Link status. If the Link LED is now SOLID ON, the previous cable is defective or not capable of supporting the link.
Link LEDs on the LEX and REX are SOLID ON , but the USB 2 and USB 3 LEDs are OFF .	<p>The host computer is not powered on.</p> <p>The LEX is not connected to a computer.</p> <p>The unit is malfunctioning.</p>	<ol style="list-style-type: none"> 1. Disconnect all USB devices from the REX 2. Disconnect LEX from the host computer. 3. Disconnect AC adapters the REX. 4. Reconnect the LEX to the host computer. 5. Reconnect the AC adapters to the REX. 6. Replace the USB cable with a different cable. 7. If the problem is not resolved, contact info@icron.com.
If, the USB 2 LED is SOLID ON , but the USB 3 LED is OFF .	<p>The LEX is not connected to a USB 3 port.</p> <p>The LEX is connected to the host using a USB 2 cable.</p> <p>The USB 3 cable connecting the LEX to the host computer is defective.</p> <p>The host computer's USB 3 controller has malfunctioned.</p> <p>The USB device connected to the REX does not support USB 3 or did not enumerate at USB 3 speeds.</p>	<ol style="list-style-type: none"> 1. Ensure that the LEX is connected to a USB 3 port on the host computer. 2. Cold boot the host computer. 3. Replace the USB cable with a different cable. 4. The USB device connected to the REX does not support USB 3 or did not enumerate at USB 3 speeds. 5. If the problem is not resolved, contact info@icron.com.

Problem	Cause	Solution
On the LEX, if USB 3 LED is SOLID ON , but the USB 2 LED is OFF .	<p>The USB cable connecting the LEX to the host computer is defective.</p> <p>The host computer's USB 2.0 controller has malfunctioned.</p> <p>The host computer does not support USB 2.</p> <p>The USB device connected to the REX does not support or did not enumerate at USB 2 speeds.</p>	<ol style="list-style-type: none"> 1. Cold boot the host computer. 2. Replace the USB 3.2 Gen 1 cable with a different cable. 3. The USB device connected to the REX does not support or did not enumerate at USB 2 speeds. 4. If the problem persists, contact info@icron.com.
Both the LEX and REX extenders are working but the USB 2 or USB 3 LEDs on the LEX and REX are blinking.	<p>The LEX and/or REX is in suspend mode. For a variety of reasons, the host computer may place the LEX/REX into suspend mode. Typically, it is because there are no USB devices attached, the USB device is asleep, or the host computer is in a sleep state or hibernating.</p>	<ol style="list-style-type: none"> 1. Recover/resume the operating system from sleep or hibernate modes (refer to your operating system's documentation). 2. Connect a USB device to the REX. 3. Use the connected device. 4. If the problem persists, contact info@icron.com.
All LEDs on both the LEX and REX units are SOLID ON , but the USB device is not operating correctly, or is detected as an "Unknown Device" in the operating system.	<p>The USB device is malfunctioning.</p> <p>The computer does not recognize the USB device.</p> <p>The application software for the USB device is not operating.</p> <p>The USB extender is malfunctioning.</p>	<ol style="list-style-type: none"> 1. Disconnect the extender from the computer 2. Connect the USB device directly to the host computer. 3. If the device does not operate as expected, consult the user documentation for the device. 4. Update the host computer BIOS, chipset, or USB controller drivers from the manufacturer's website. 5. If the device operates as expected when directly connected to the computer, connect another device to the extender and reconnect it to the host computer. 6. If the second device does not operate, the extender may be malfunctioning. Contact info@icron.com. 7. If the second device operates as expected, then the first device may not be compatible with this extender. Contact info@icron.com.

Problem	Cause	Solution
<p>A USB 3 device is not enumerating as USB 3, or the operating system is notifying the user that the device can "Perform Faster if connected to a USB 3 port."</p>	<p>The USB device is malfunctioning.</p> <p>The computer does not recognize the USB device.</p> <p>The application software for the USB device is not operating.</p> <p>The USB 3 port on the computer is malfunctioning.</p> <p>The USB extender is malfunctioning.</p>	<ol style="list-style-type: none"> 1. Disconnect the extender from the computer. 2. Connect the USB 3 device directly to the host computer. 3. If the device does not operate as expected as a USB 3 device, consult the user documentation for that device or try a different USB port on the host computer. 4. Update the host computer BIOS, chipset or USB controller drivers from the manufacturer's website. 5. If the device operates as a USB 3 device when directly connected to the computer, connect another USB 3 device to the extender and reconnect it to the host computer. 6. If the second device does not operate as a USB 3 device, the extender may be malfunctioning. Contact info@icron.com. 7. If the second device operates as a USB 3 device as expected, then the first device may not be compatible with this extender. Contact info@icron.com.
<p>The Link LEDs on the Local Extender and Remote Extenders are solid ON, but the Video LED is OFF.</p>	<p>The source device is not powered on or asleep.</p> <p>The Local Extender is not connected to a DisplayPort source.</p> <p>The Remote Extender is not connected to a DisplayPort sink, or the sink is turned off.</p> <p>The source and sink have negotiated an unsupported resolution or refresh rate.</p> <p>The extender system is malfunctioning.</p>	<ol style="list-style-type: none"> 1. Disconnect the video connections from the sink and source. 2. Disconnect the AC adapters from the Local and Remote extenders. 3. Cold boot the host computer/DisplayPort source. 4. Reconnect the USB-C connection from the Local Extender to the DisplayPort source. 5. Reconnect the USB-C connection from the Remote Extender to the DisplayPort sink. Ensure the sink is on. 6. Reconnect the AC adapters to the Local and Remote Extenders. 7. If the problem is not solved, contact info@icron.com.

Problem	Cause	Solution
The Link and Video LEDs are solid ON , but there is no video on the DisplayPort sink.	<p>The DisplayPort sink device is malfunctioning.</p> <p>The DisplayPort source is malfunctioning.</p> <p>The Remote Extender is not connected to a DisplayPort sink.</p>	<ol style="list-style-type: none"> 1. Disconnect the video connections from the sink and source. 2. Disconnect the AC adapters from the Local and Remote Extenders. 3. Restart the host computer/ DisplayPort source. 4. Connect the sink directly to the source to ensure it operates properly. 5. If the sink does operate directly connected to the source, try connecting another sink device through the extender system. 6. Reconnect the USB-C connection from the Local Extender to the DisplayPort source. 7. Reconnect the video connection from the Remote connection to the DisplayPort sink. 8. Reconnect the AC adapters to the Local and Remote Extenders. 9. If the problem is not solved, contact info@icron.com.
All LEDs are flashing and the system is operational.	Unit is or was operating at an unsafe temperature.	<ol style="list-style-type: none"> 1. Check ambient temperature. Ensure temperature does not exceed 50°C (122°F). 2. Power cycle the unit to remove LED status.
All LEDs are flashing and the system is NOT operational.	Unit has exceeded safe operating temperature.	<ol style="list-style-type: none"> 1. Remove external sources of heat or change location of the unit. 2. Power cycle the unit to return to operation.
LEDs are scrolling LEFT to RIGHT, starting with Status.	Unit is programming.	<ol style="list-style-type: none"> 1. Wait for the unit to finish programming.

Specifications

Range	
Point-to-Point	100m (330 ft) over CAT 6a UTP Cable or better

Video Support	
Maximum Resolution	4196x2160
Color	RGB 8/10, YCbCr 4:4:4, 4:2:2
Lane Count/Rate	4, 2 or 1 Lane operation up to HBR3 8.1Gbps
Control	DisplayPort MCCC
EDID	EDID override supported
HDCP Version	2.2

USB Device Support	
USB Standards	USB 3.2 Gen 1, USB 2.0, and USB 1.1 up to 5Gbps
Device Compatibility	All Device Types and Classes (Control, Interrupt, Bulk, and Isochronous)
Host Compatibility	OHCI, UHCI, EHCI, xHCI
Available Current at REX	3A (15W)
Maximum Devices	Supports up to 31 devices
USB Hub/Tier Consumed	0

Mechanical Data		
Specification	LEX (Local Extender)	REX (Remote Extender)
USB Connector	1x USB-C Receptacle	
Link Connector	1x RJ45 Ethernet Link	
Power Input	5V DC 3A Barrel Jack	5V DC 5A Barrel Jack
Dimensions (WxDxH)	137mm x 100mm x 26mm (5.4"x3.9"x 1.0")	
Weight	300g (0.7lbs.)	
Enclosure Material	Black Anodized Aluminum	

Environmental	
Temperature Range	0°C - 40°C (32°F-104°F) Operating / -20°C-70°C (-4°F-158°F) Storage
Relative Humidity	20% to 80% Operating / 10% to 90% Storage (Non-condensing)

Compliance & Warranty	
Certifications	FCC (Class A), CE, RCM, UKCA, IEC/UL/cUL, ICES-003 Issue 7
Country of Origin	Taiwan (TAA Compliant)
Warranty	3 years

Warranty Information

Limited Hardware Warranty

Icron, a registered trademark of SyncBridge Technologies Corporation, warrants that any hardware products accompanying this documentation shall be free from significant defects in material and workmanship for a period of three years from the date of purchase. Icron's hardware warranty extends to Licensee, its customers and end users. The Warranty does not include repair of failures caused by misuse, neglect, accident, modification, operation outside a normal operating environment, failure caused by service of the device by non-authorized servicers or a product for which Icron is not responsible. Opening the enclosures will void warranty.

Hardware Remedies

SyncBridge/Icron's entire liability and the Licensee's exclusive remedy for any breach of warranty shall be, at Icron's option, either (a) return of the price paid, or (b) repair or replacement of hardware, which will be warranted for the remainder of the original warranty period or 30 days, whichever is longer. These remedies are void if failure of the hardware has resulted from accident, abuse, or misapplication.

Limitation of Liability

The hardware warranty set forth in this agreement replaces all other warranties. SyncBridge/Icron expressly disclaims all other merchantability and fitness for a particular purpose and noninfringement of third-party rights with respect to the hardware. Icron dealer, agent, or employee is not authorized to make any modification extension or addition to this warranty. Under no circumstances will Icron, its suppliers or licensors be liable for any costs of procurement or substitute products or services, lost profits, loss of information or data, or any other special, indirect, consequential, or incidental damages arising in any way out of the sale of, use of, or inability to use Icron product or service, even if Icron, its suppliers or licensors have been advised of the possibility of such damages. In no case shall Icron, its suppliers and licensors' liability exceed the actual money paid for the products at issue.

Since some jurisdictions do not allow the limitation of implied warranties of liability for incidental, consequential, special or indirect damages, the above limitation may not always apply. The above limitations will not apply in case of personal injury where and to the extent that applicable law requires such liability.

Obtaining Warranty Service

To obtain warranty service, contact the SyncBridge/Icron technical support team within the warranty period to obtain a Return Material Authorization (RMA) number as returns cannot be accepted without one.

Contacting Technical Support

For technical support, please contact us at info@icron.com.

Please include the following information when reaching out for technical support:

- Description of the problem
- Part number and serial numbers for both LEX and REX units
- Host computer(s) make and model
- Type of Operating System installed (e.g. Windows 10, macOS 11.1, etc.)
- Make and model of any USB device(s) attached to this extension system
- Description of the installation such as host computer model, transmission media used and information about the USB device(s)

Technical Glossary

Category 6a (CAT 6a) Network Cabling

Category 6a cable is commonly also referred to as CAT 6a. This cabling is available in either solid or stranded twisted pair copper wire variants and as UTP (Unshielded Twisted Pair) or STP (Shielded Twisted Pair). UTP cables are not surrounded by any shielding making them more susceptible to Electromagnetic Interference (EMI). STP cables include shielding the copper wires and provides better protection against EMI.

USB 3, USB 2.0 and USB-C Cables

USB cables have two distinct full-sized connectors. The Type A connector is used to connect the cable from a USB device to the Type A port on a computer or hub. The Type B connector is used to attach the USB cable to a USB device. The Type-C connector is used to connect to both USB hosts and devices.

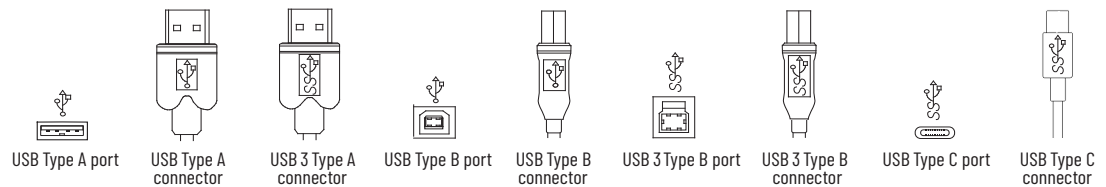

RJ45

The Registered Jack (RJ) physical interface is what connects the network cabling (CAT 5e/6/7) to the LEX and REX units. You may use either the T568A scheme (Table 1) or the T568B scheme (Table 2) for cable termination as this extender system requires all four pairs of the cable. RJ45 connectors are sometimes also referred to as 8P8C connectors. Note that any given cable must be terminated using the same T568 scheme on both ends to operate correctly.

RJ45 Pin Positioning

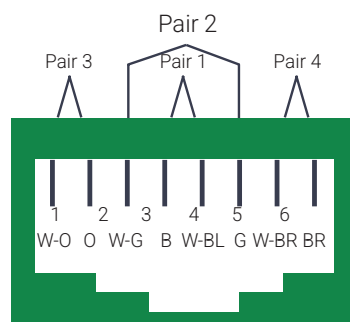
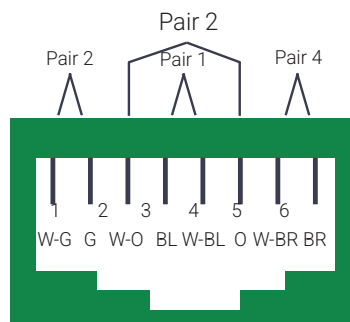

Table 1 - T568A Wiring

Pin	Pair	Wire	Cable / Color
1	3	1	White / Green
2	3	2	Green
3	2	1	White / Orange
4	1	2	Blue
5	1	1	White / Blue
6	2	2	Orange
7	4	1	White / Brown
8	4	2	Brown

Table 2 - T568B Wiring

Pin	Pair	Wire	Cable / Color
1	2	1	White / Orange
2	2	2	Orange
3	3	1	White / Green
4	1	2	Blue
5	1	1	White / Blue
6	3	2	Green
7	4	1	White / Brown
8	4	2	Brown



Icron - a registered trademark of
SyncBridge Technologies Corporation
Suite 100, 4664 Lougheed Hwy.
Burnaby, BC, V5C 5T5, Canada

info@icron.com | icron.com

