

USB 3-2-1 Raven™ 3301

1-Port USB 3.2, 100m CAT 5e Extender System



Thank you for purchasing the Icron USB 3-2-1 Raven 3301.

Please read this user guide thoroughly.

FCC Radio Frequency Interference Statement Warning

This device complies with part 15 of the FCC Rules. Operation is subject to the following two conditions: (1) this device may not cause harmful interference, and (2) this device must accept any interference received including interference that may cause undesired operation.

CE Statement

We, SyncBridge Technologies Corporation, declare under our sole responsibility that the USB 3-2-1 Icron Raven 3301, to which this declaration relates, is in conformity with European Standards EN 55032, EN 55035, EMC Directive: 2014/30/EU, EN 62368-1, RoHS Directive 2011/65/EU + 2015/863/EU, EMC Directive 2014/30/EU, LVD Directive 2014/35/EU, and ErP Directive 2009/125/EC.

Industry Canada Statement

This Class A digital apparatus complies with Canadian ICES-003. CAN ICES-3 (A) / NMB-3 (A)

WEEE Statement

The European Union has established regulations for the collection and recycling of all waste electrical and electronic equipment (WEEE). Implementation of WEEE regulations may vary slightly by individual EU member states. Please check with your local and state government guidelines for safe disposal and recycling or contact your national WEEE recycling agency for more information.

Product Operation and Storage

Please read and follow all instructions provided with this product and operate it for intended use only. Do not attempt to open the product casing as this may cause damage and will void the warranty. Use only the power supply provided with this product. When not in use, this product should be stored in a dry location between -20°C and 70°C.



Table of Contents

Introduction	4
Product Contents	4
Features	4
Quick Start Guide	5
The LEX Unit	6
The REX Unit	7
Installation Guide	8
Raven 3301 Category Cabling Guidelines	8
Installing the Raven 3301	8
Requirements	8
Preparing Your Site	8
Installing the LEX Unit	9
Installing the REX Unit	9
Connecting the LEX to the REX	9
Checking the Installation	10
Connecting a USB Device	10
Compatibility	10
USB Extender Mounting Options	11
Option 1: USB Extender Mounting Kit	11
Option 2: USB Extender Direct Surface Mounting	12
Direct Surface Mounting Measurement Stencil	12
Troubleshooting	13
Specifications	16
Warranty Information	17
Limited Hardware Warranty	17
Hardware Remedies	17
Limitation of Liability	17
Obtaining Warranty Service	17
Contacting Technical Support	18
Technical Glossary	19

Introduction

This guide provides product information for the Raven 3301, installation instructions and troubleshooting guidelines. The instructions in this guide assume a general knowledge of computer installation procedures, familiarity with cabling requirements and some understanding of USB devices.

NOTE: Notes provide additional useful information.

CAUTION: Cautions provide important information about an operational requirement.

Product Contents

Your Raven 3301 extender system contains:

- Raven 3301 LEX (Local Extender)
- Raven 3301 REX (Remote Extender)
- 5V DC 4A Power Adapter
- 1x Country Specific Power Cord
- Warranty and Compliance Insert

Features

The Raven 3301 incorporates ExtremeUSB® technology, enabling users to extend USB 3 beyond the standard 3m cable limit for USB-C peripheral devices. This extender system is composed of two individual units, the LEX and the REX, with the following key features:

- Extends USB 3.2 Gen 1, USB 2.0 and USB 1.1 devices up to 100m over a single CAT 5e cable
- Support for all USB 4 and older Gen 1/2 host controllers and devices (up to 5Gbps)
- Supports all USB transaction types (Control, Interrupt, Bulk, and Isochronous)
- The REX includes 1 USB-C port (delivers 3A at the USB-C port)
- Compatible with all major Unified Communications conferencing applications
- TAA Compliant

The Raven 3301 includes the ExtremeUSB® suite of features:

- Transparent USB extension
- True plug and play; no software drivers required
- Works with all major operating systems; Windows®, macOS™, Linux® and ChromeOS™

Quick Start Guide

Before you get started, ensure that all the drivers required for your USB device(s) are installed.

- 1 Place extenders where desired and connect the CAT 5e extension link cabling to the Link ports (RJ45) on the LEX and REX.

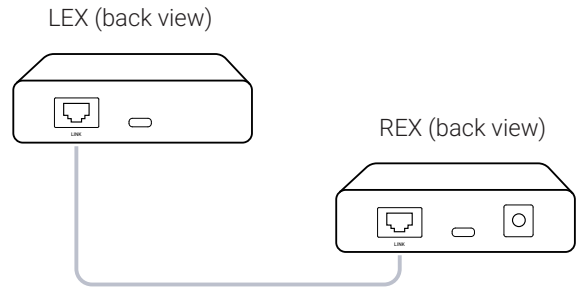

- 2 Connect the LEX to the computer using a USB 3 cable with a USB-C connector on one side, or both, depending on your port configuration.

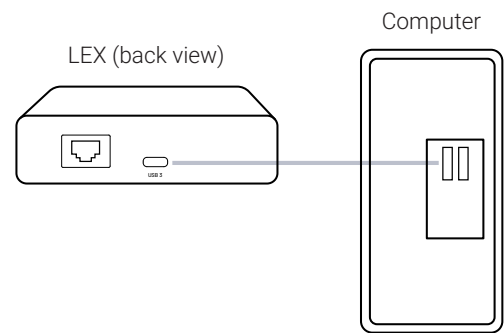

- 3 Connect the REX to the AC adapter and plug it into a power source.

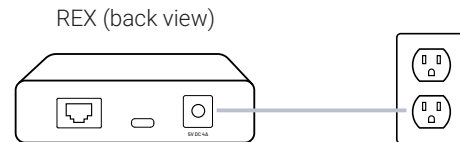

- 4 Attach the USB device(s) to the REX.

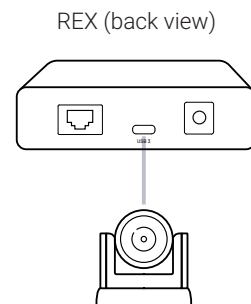

The LEX Unit

The LEX (Local Extender) is powered by the USB connection to the host computer and uses a standard USB-C cable (not included).

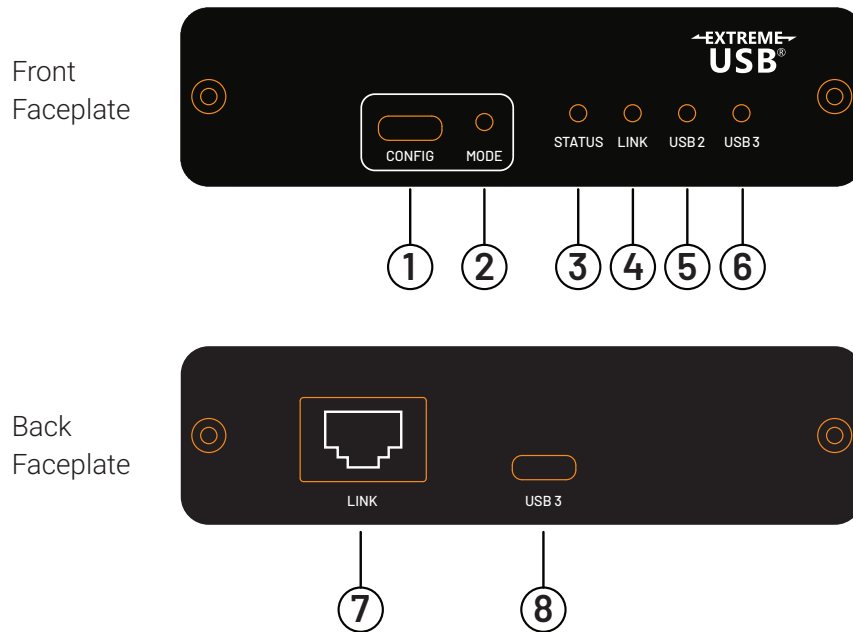

Item	Type	Description
1	Config	Reserved for manufacturer use.
2	Mode	Reserved for manufacturer use.
3	Status LED	LED is SOLID ON when system is functioning normally. LED BLINKS when system is booting or to indicate a temperature warning in unison with the LINK, USB 2, and USB 3 LEDs.
4	Link LED	LED is SOLID ON when LEX is linked to an opposite REX. LED is OFF when there is no connection between the LEX and REX units.
5	USB 2 LED	LED is SOLID ON when an active USB 2 connection is established through the extender system. LED BLINKS when the USB 2 connection is suspended/asleep. LED is OFF when no USB 2 connection is detected.
6	USB 3 LED	LED is SOLID ON when an active USB 3 connection is established through the extender system. LED BLINKS when the USB 3 connection is suspended/asleep. LED is OFF when no USB 3 connection is detected.
7	Link Port (RJ45)	Accepts RJ45 connector for CAT 5e cabling to connect the LEX to the REX.
8	USB Host Port	USB-C receptacle used to connect LEX to the USB 3 host computer.

The REX Unit

The (REX) Remote Extender unit provides a single USB-C receptacle for standard USB devices up to 5Gbps. Up to 31 devices may be connected by attaching USB hubs to the REX. Powered by an external 5V DC 4A adapter, the REX supplies 3A at the USB-C port.

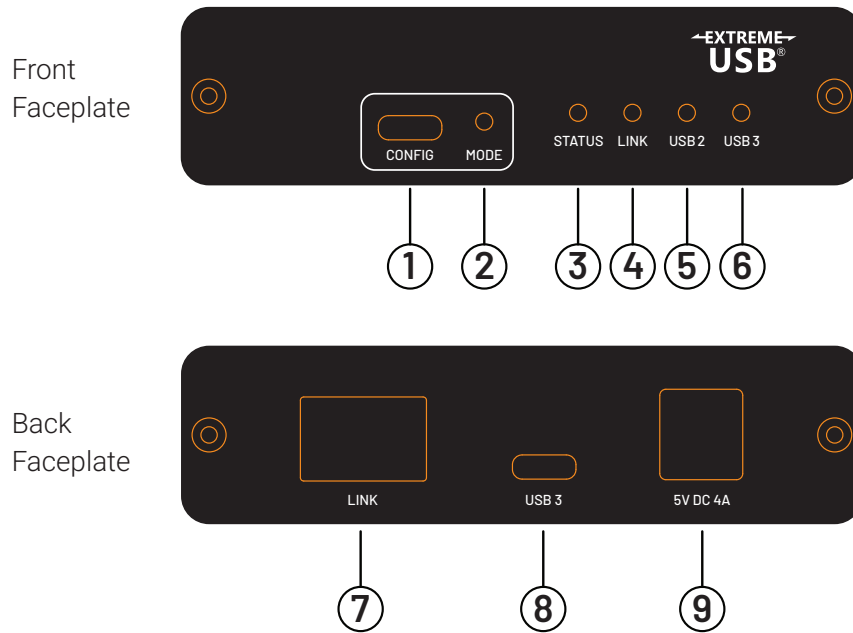

Item	Type	Description
1	Config	Reserved for manufacturer use.
2	Mode	Reserved for manufacturer use.
3	Status LED	LED is SOLID ON when system is functioning normally. LED BLINKS when system is booting or to indicate a temperature warning in unison with the LINK, USB 2, and USB 3 LEDs.
4	Link LED	LED is SOLID ON when REX is linked to an opposite LEX. LED is OFF when there is no connection between the LEX and REX units.
5	USB 2 LED	LED is SOLID ON when an active USB 2 connection is established through the extender system. LED BLINKS when the USB 2 connection is suspended/asleep. LED is OFF when no USB 2 connection is detected.
6	USB 3 LED	LED is SOLID ON when an active USB 3 connection is established through the extender system. LED BLINKS when the USB 3 connection is suspended/asleep. LED is OFF when no USB 3 connection is detected.
7	Link Port (RJ45)	Accepts RJ45 connector for CAT 5e cabling to connect the REX to the LEX
8	Device Port (USB-C)	Accepts all USB devices.
9	DC Power Port	Connector for the included power adapter -- accepts 5V DC 4A

Installation Guide

Raven 3301 Category Cabling Guidelines

The Raven 3301 requires a minimum grade of Category (CAT) 5e Unshielded (UTP) cabling to be used in order to reach 100m (330 ft) of extension distance. CAT 6 or CAT 6a/7 may be used but it is not necessary.

NOTE: The total distance of 100m also includes the length of the patch cable should one be required. Up to 10m of patch cable can be used, although the remaining 90m distance must consist of solid core premise cabling.

Installing the Raven 3301

Requirements

To complete the installation, you will also require the following items that are not included with this system:

- USB compatible computer (host computer) with a USB compliant operating system
- USB compatible device(s)
- CAT 5e cabling with two information outlets and two CAT 5e patch cords with RJ45 connectors (if using premise cabling), ensuring the total cable length does not exceed 100m

Preparing Your Site

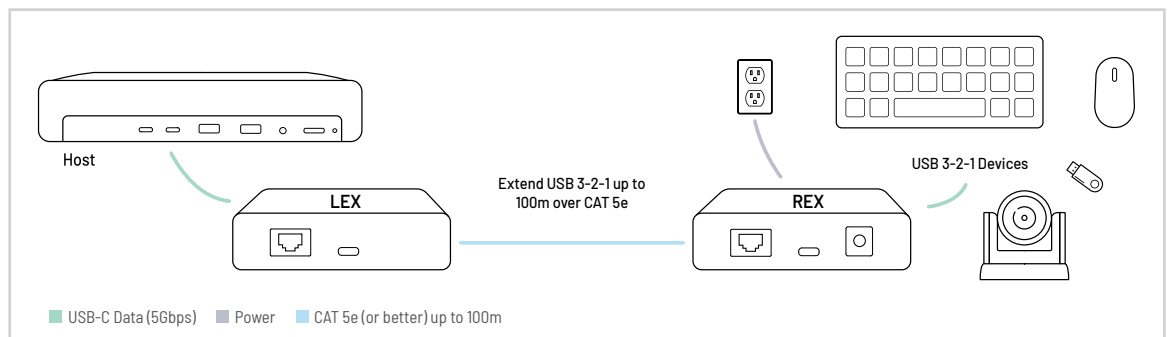

Before installing this system, you will need to prepare your site:

1. Position your computer in the desired location and complete the setup.
2. Ensure to locate your USB device(s) within the 100m range of your CAT 5e cable. If not adjust the location of your device(s) and/or computer accordingly.

NOTE: If you are using surface cabling, the Raven 3301 supports a maximum distance of 100m. Install the CAT 5e cabling as desired and terminate it with the appropriate RJ45 ends. If using premise cabling, (in-building network infrastructure), ensure your cabling is installed between the two locations and does not exceed 100m and that it meets CAT 5e specification.

CAUTION: Cable installation is important, particularly if high throughput applications are used. Ensure the cable is installed away from, or isolated from potential sources of interference such as electrical wiring, fluorescent lighting, etc.

Installing the LEX Unit

1. Place the LEX unit near the computer.
2. Connect a USB-C cable between the LEX host port and to a USB port on your host computer.

Installing the REX Unit

1. Place the REX near the USB device(s).
2. Assemble the 5V 4A power adapter and country specific power cord together and connect them into a suitable AC outlet.
3. Connect the power adapter to the REX.

Connecting the LEX to the REX

With Surface Cabling:

1. Plug one end of the CAT 5e cable (not included) into the Link port (outermost RJ45 connector) on the LEX.
2. Plug the other end of the CAT 5e cable into the Link port (outermost RJ45 connector) on the REX.

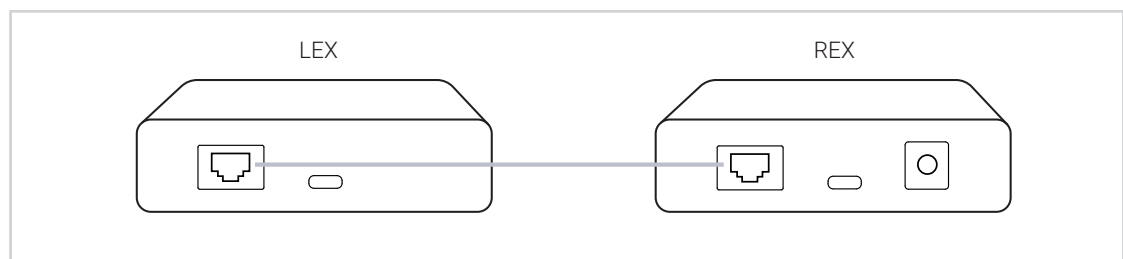

With Premise Cabling:

1. Plug one end of a CAT 5e patch cord (not included) into the Link port (RJ45 connector) on the LEX.
2. Plug the other end of the patch cord into the CAT 5e information outlet near the host computer.
3. Plug one end of the second CAT 5e patch cord (not included) into the Link port (RJ45 connector) on the REX.
4. Plug the other end of the patch cord into the CAT 5e information outlet near the USB device.

NOTE: Do not exceed more than 10m total of patch cable when using premise cabling.

Checking the Installation

5. On the LEX and REX units, check that the Status, Link, USB 2 and USB 3 LEDs are on. If the Link LEDs are permanently off, then the cabling between the LEX and REX units may not be installed properly or is defective.
6. If the Raven 3301 is not detected correctly or fails to detect, please consult the Troubleshooting section in this guide.

Connecting a USB Device

1. Install any software required to operate your USB device(s). Refer to the documentation for the USB device(s), as required.
2. Connect the USB device to the device port on the REX.
3. Check that the device is detected and installed properly in the operating system.

Compatibility

The Raven 3301 complies with USB 2.0 and USB 3.2 Gen 1 (5Gbps) specifications governing the design of USB devices. However, there is no guarantee that all USB devices or hosts will be compatible as there are a number of different characteristics that may impact the operation of USB devices over extended distances.

NOTE: The Raven 3301 does not support DP Alt mode for USB-C. USB data is supported. For applications requiring DP Alt mode, please inquire about the Icron DP 4K Video + USB 3-2-1 Arbutus 63301 extender.

USB Extender Mounting Options

The bottom of the Raven 3301 enclosure features four convenient pre-drilled holes for optional mounting. Based on your requirements, choose from two available mounting options:

1. Extender Mounting Kit (purchased separately)
Order Part #10-00780-A01 Raven/Arbutus Mounting Kit - Black
2. USB Extender Direct Surface Mounting
(Use your own hardware and follow instructions listed on the next page)

Option 1: USB Extender Mounting Kit

Each 10-00780-A01 part includes:

- 2 mounting brackets
- 4 (M2.5x8mm) Philips raised cheese head screws with split locking washers
- Mounting bracket installation guide

NOTE: 1 kit required to mount LEX or REX unit, 2 kits per system.

Use a Phillips screwdriver to fasten and secure the mounting bracket into place using the provided screws as illustrated.

Once both mounting brackets are secured onto the extender, it is ready for mounting onto a surface.

NOTE: You will need to provide your own screws to secure the extender onto the desired surface using the available slots on each bracket.

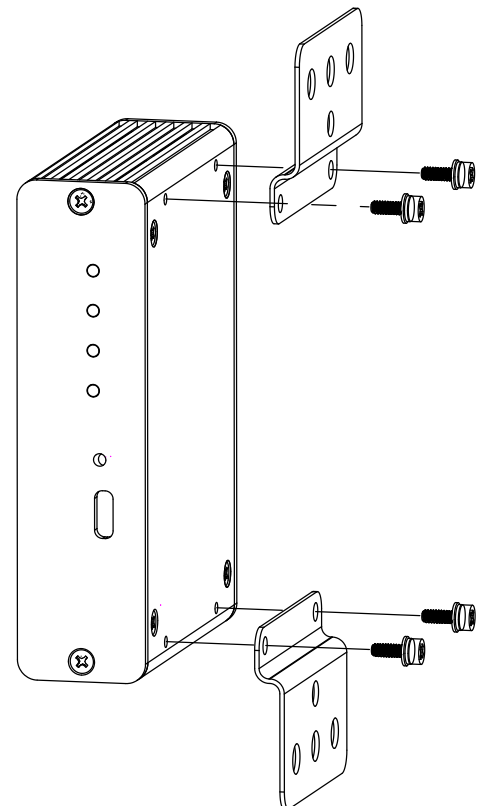

Option 2: USB Extender Direct Surface Mounting

Use your own hardware.

The bottom of the enclosure has four pre-drilled holes for surface mounting.
 Distance between the enclosure mounting holes:
 42.0mm x 88.5mm

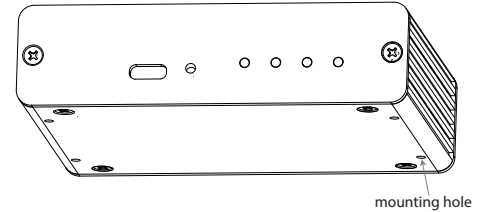

1. Mark the center point of each of the four holes on your mounting surface either by directly measuring or using this stencil.
2. Hardware recommendation: M2.5 locking washers and M2.5 screws (4 of each per extender) noting screw length will depend upon thickness of mounting surface.
3. Drill through each of the four hole markings on the mounting surface using a 3.70mm (0.1457") drill bit.
4. Align the bottom enclosure holes to the newly drilled out holes on the mounting surface.
5. Place a locking washer on each of the four screws and using a screwdriver, fasten the extender into place.

NOTES: Do not exceed a screw depth of 10mm (0.4") into the unit or damage may occur. To print this stencil to scale, either select the print dialogue box to "actual size" or set page scaling to "none".



Troubleshooting

The following table provides troubleshooting tips. The topics are arranged in the order in which they should be executed in most situations. If you are unable to resolve the problems after following these instructions, please contact us at info@icron.com for assistance.

Problem	Cause	Solution
All the LEDs are OFF on the LEX and/or REX.	The LEX is not receiving power from the host and/or the REX unit is not receiving power from the AC power adapter.	<ol style="list-style-type: none"> 1. Ensure that the AC power adapter is properly connected to the REX. 2. Ensure the LEX is plugged into the host with a USB Cable. 3. Check that the AC adapter is properly connected to a live source of AC power. 4. Check if the LEX and/or REX Status LED is illuminated.
Status LED is OFF .	The unit has malfunctioned and requires re-programming.	<ol style="list-style-type: none"> 1. For assistance, contact info@icron.com.
Link LEDs on the LEX and the REX are OFF .	There is no connection between the LEX and REX units.	<ol style="list-style-type: none"> 1. Ensure no more than 100m of CAT 5e cabling is connected between the LEX and REX. 2. Connect a short patch cable between the LEX and REX. Recheck the Link status. If the Link LED is now SOLID ON, the previous cable is defective or not capable of supporting the link.
Link LEDs on the LEX and REX are SOLID ON , but the USB 2 and USB 3 LEDs are OFF .	<p>The host computer is not powered on.</p> <p>The LEX is not connected to a computer.</p> <p>The unit is malfunctioning.</p>	<ol style="list-style-type: none"> 1. Disconnect all USB devices from the REX 2. Disconnect LEX from the host computer. 3. Disconnect AC adapters the REX. 4. Reconnect the LEX to the host computer. 5. Reconnect the AC adapters to the REX. 6. Replace the USB cable with a different cable. 7. If the problem is not resolved, contact info@icron.com.
If the LEX USB 2 LED is SOLID ON , but the USB 3 LED is OFF .	<p>The LEX is not connected to a USB 3 port.</p> <p>The LEX is connected to the host using a USB 2 cable.</p> <p>The USB 3 cable connecting the LEX to the host computer is defective.</p> <p>The host computer's USB 3 controller has malfunctioned.</p> <p>The USB device connected to the REX does not support USB 3 or did not enumerate at USB 3 speeds.</p>	<ol style="list-style-type: none"> 1. Ensure that the LEX is connected to a USB 3 port on the host computer. 2. Cold boot the host computer. 3. Replace the USB cable with a different cable. 4. Consult the USB device's user guide to verify if the device is in fact operating properly. 5. If the problem is not resolved, contact info@icron.com.

Problem	Cause	Solution
On the LEX, if USB 3 LED is SOLID ON but the USB 2 LED is OFF .	<p>The USB cable connecting the LEX to the host computer is defective.</p> <p>The host computer's USB 2.0 controller has malfunctioned.</p> <p>The host computer does not support USB 2.</p> <p>The USB device connected to the REX does not support or did not enumerate at USB 2 speeds.</p>	<ol style="list-style-type: none"> 1. Ensure that the included USB 3 cable is being used between the host computer and LEX. 2. Cold boot the host computer. 3. Replace the USB 3.1 Gen 1 cable with a different cable. 4. Consult the USB device's user guide to verify if device is in fact operating properly. 5. If the problem persists, contact info@icron.com.
Both the LEX and REX extenders are working but the USB 2 or USB 3 LEDs on the LEX and REX are blinking.	<p>The LEX and/or REX is in suspend mode. For a variety of reasons, the host computer may place the LEX/REX into suspend mode. Typically, it is because there are no USB devices attached, the USB device is asleep, or the host computer is in a sleep state or hibernating.</p>	<ol style="list-style-type: none"> 1. Recover/resume the operating system from sleep or hibernate modes (refer to your operating system's documentation). 2. Connect a USB device to the REX. 3. Use the connected device. 4. If the problem persists, contact info@icron.com.
All LEDs on both the LEX and REX units are SOLID ON , but the USB device is not operating correctly, or is detected as an "Unknown Device" in the operating system.	<p>The USB device is malfunctioning.</p> <p>The computer does not recognize the USB device.</p> <p>The application software for the USB device is not operating.</p> <p>The USB extender is malfunctioning.</p>	<ol style="list-style-type: none"> 1. Disconnect the extender from the computer 2. Connect the USB device directly to the host computer. 3. If the device does not operate as expected, consult the user documentation for the device. 4. Update the host computer BIOS, chipset, or USB controller drivers from the manufacturer's website. 5. If the device operates as expected when directly connected to the computer, connect another device to the extender and reconnect it to the host computer. 6. If the second device does not operate, the extender may be malfunctioning. Contact info@icron.com. 7. If the second device operates as expected, then the first device may not be compatible with this extender. Contact info@icron.com.

Problem	Cause	Solution
A USB 3 device is not enumerating as USB 3, or the operating system is notifying the user that the device can "Perform Faster if connected to a USB 3 port."	<p>The USB device is malfunctioning.</p> <p>The computer does not recognize the USB device.</p> <p>The application software for the USB device is not operating.</p> <p>The USB 3 port on the computer is malfunctioning.</p> <p>The USB extender is malfunctioning.</p>	<ol style="list-style-type: none"> 1. Disconnect the extender from the computer. 2. Connect the USB 3 device directly to the host computer. 3. If the device does not operate as expected as a USB 3 device, consult the user documentation for that device or try a different USB port on the host computer. 4. Update the host computer BIOS, chipset or USB controller drivers from the manufacturer's website. 5. If the device operates as a USB 3 device when directly connected to the computer, connect another USB 3 device to the extender and reconnect it to the host computer. 6. If the second device does not operate as a USB 3 device, the extender may be malfunctioning. Contact info@icron.com. 7. If the second device operates as a USB 3 device as expected, then the first device may not be compatible with this extender. Contact info@icron.com.
All LEDs are flashing and the system is operational.	Unit is or was operating at an unsafe temperature.	<ol style="list-style-type: none"> 1. Check ambient temperature. Ensure temperature does not exceed 50°C (122°F). 2. Power cycle the unit to remove LED status.
All LEDs are flashing and the system is NOT operational.	Unit has exceeded safe operating temperature.	<ol style="list-style-type: none"> 1. Remove external sources of heat or change location of the unit. 2. Power cycle the unit to return to operation.
LEDs are scrolling LEFT to RIGHT, starting with Status.	Unit is programming.	<ol style="list-style-type: none"> 1. Wait for the unit to finish programming.

Specifications

Range	
Point-to-Point	100m (330 ft) over CAT 5e UTP Cable or better

USB Device Support	
USB Standards	USB 3.2 Gen 1, USB 2.0, and USB 1.1 up to 5Gbps
Device Compatibility	All Device Types and Classes (Control, Interrupt, Bulk, and Isochronous)
Host Compatibility	OHCI, UHCI, EHCI, xHCI
Available Current at REX	3A (15W)
Maximum Devices	Supports up to 31 devices
USB Hub/Tier Consumed	0

Local Extender (LEX)	
USB Connector	1 x USB-C Receptacle
Link Connector	1 x RJ45 "Link" Port
Dimensions (W x D x H) and Weight	100.0mm x76.0mm x 25.4mm (3.9"x3.0"x 1.0") 210g (0.46lbs.)
Enclosure Material	Black Anodized Aluminum

Remote Extender (REX)	
USB Connector	1x USB-C Receptacle
Link Connector	1 x RJ45 "Link" Port
Dimensions (W x D x H*) and Weight	100.0mm x76.0mm x 25.4mm (3.9"x3.0"x 1.0") 210g (0.46lbs.)
Power Supply	100-240V AC Input, 5V DC 4A Output Jack
Enclosure Material	Black Anodized Aluminum

Box Measurements	
Package Dimensions (W x D x H)	241.0mm x172.0mm x57.0mm (6.1"x4.4"x1.4")
Package Weight	907g (2.0lbs)

Environmental	
Temperature Range	0°C - 40°C (32°F-104°F) Operating / -20°C-70°C (-4°F-158°F) Storage
Relative Humidity	20% to 80% Operating / 10% to 90% Storage (Non-condensing)

Compliance & Warranty	
Certifications	FCC (Class A), CE, RCM, UKCA, IEC/UL/cUL, ICES-003 Issue 7
Country of Origin	Taiwan (TAA Compliant)
Warranty	3 years

Warranty Information

Limited Hardware Warranty

Icron, a registered trademark of SyncBridge Technologies Corporation, warrants that any hardware products accompanying this documentation shall be free from significant defects in material and workmanship for a period of three years from the date of purchase. Icron's hardware warranty extends to Licensee, its customers and end users. The Warranty does not include repair of failures caused by misuse, neglect, accident, modification, operation outside a normal operating environment, failure caused by service of the device by non-authorized servicers or a product for which Icron is not responsible. Opening the enclosures will void warranty.

Hardware Remedies

SyncBridge/Icron's entire liability and the Licensee's exclusive remedy for any breach of warranty shall be, at Icron's option, either (a) return of the price paid, or (b) repair or replacement of hardware, which will be warranted for the remainder of the original warranty period or 30 days, whichever is longer. These remedies are void if failure of the hardware has resulted from accident, abuse, or misapplication.

Limitation of Liability

The hardware warranty set forth in this agreement replaces all other warranties. SyncBridge/Icron expressly disclaims all other merchantability and fitness for a particular purpose and noninfringement of third-party rights with respect to the hardware. Icron dealer, agent, or employee is not authorized to make any modification extension or addition to this warranty. Under no circumstances will Icron, its suppliers or licensors be liable for any costs of procurement or substitute products or services, lost profits, loss of information or data, or any other special, indirect, consequential, or incidental damages arising in any way out of the sale of, use of, or inability to use Icron product or service, even if Icron, its suppliers or licensors have been advised of the possibility of such damages. In no case shall Icron, its suppliers and licensors' liability exceed the actual money paid for the products at issue.

Since some jurisdictions do not allow the limitation of implied warranties of liability for incidental, consequential, special or indirect damages, the above limitation may not always apply. The above limitations will not apply in case of personal injury where and to the extent that applicable law requires such liability.

Obtaining Warranty Service

To obtain warranty service, contact the SyncBridge/Icron technical support team within the warranty period to obtain a Return Material Authorization (RMA) number as returns cannot be accepted without one.

Contacting Technical Support

For technical support, please contact us at info@icron.com.

Please include the following information when reaching out for technical support:

- Description of the problem
- Part number and serial numbers for both LEX and REX units
- Host computer(s) make and model
- Type of Operating System installed (e.g. Windows 10, macOS 11.1, etc.)
- Make and model of any USB device(s) attached to this extension system
- Description of the installation such as host computer model, transmission media used and information about the USB device(s)

Technical Glossary

Category 5e (CAT 5e) Network Cabling

Category 5e cable is commonly also referred to as CAT 5e. This cabling is available in either solid or stranded twisted pair copper wire variants and as UTP (Unshielded Twisted Pair) or STP (Shielded Twisted Pair). UTP cables are not surrounded by any shielding making them more susceptible to Electromagnetic Interference (EMI). STP cables include shielding the copper wires and provides better protection against EMI.

USB 3, USB 2.0 and USB-C Cables

USB cables have two distinct full-sized connectors. The Type A connector is used to connect the cable from a USB device to the Type A port on a computer or hub. The Type B connector is used to attach the USB cable to a USB device. The Type-C connector is used to connect to both USB hosts and devices.

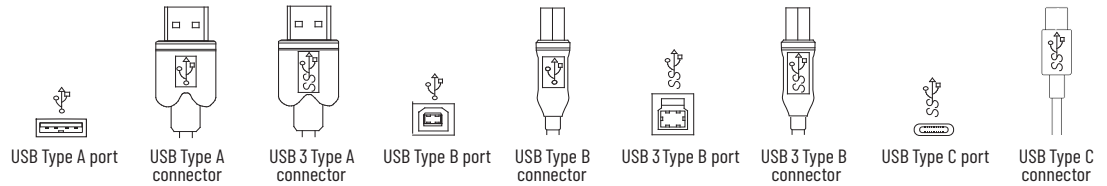

RJ45

The Registered Jack (RJ) physical interface is what connects the network cabling (CAT 5e/6/7) to the LEX and REX units. You may use either the T568A scheme (Table 1) or the T568B scheme (Table 2) for cable termination as this extender system requires all four pairs of the cable. RJ45 connectors are sometimes also referred to as 8P8C connectors. Note that any given cable must be terminated using the same T568 scheme on both ends to operate correctly.

RJ45 Pin Positioning

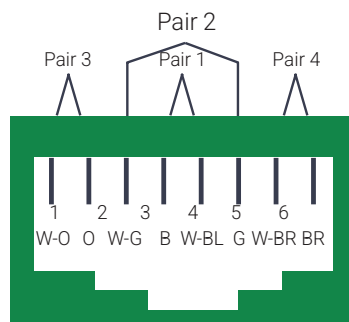
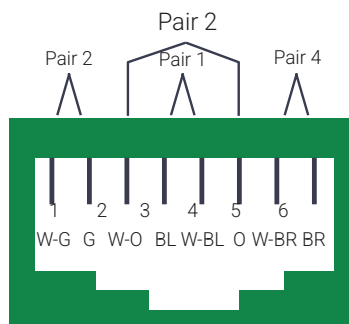

Table 1 - T568A Wiring

Pin	Pair	Wire	Cable / Color
1	3	1	White / Green
2	3	2	Green
3	2	1	White / Orange
4	1	2	Blue
5	1	1	White / Blue
6	2	2	Orange
7	4	1	White / Brown
8	4	2	Brown

Table 2 - T568B Wiring

Pin	Pair	Wire	Cable / Color
1	2	1	White / Orange
2	2	2	Orange
3	3	1	White / Green
4	1	2	Blue
5	1	1	White / Blue
6	3	2	Green
7	4	1	White / Brown
8	4	2	Brown



Icron a registered trademark of
SyncBridge Technologies Corporation
Suite 100, 4664 Lougheed Hwy.
Burnaby, BC, V5C 5T5, Canada

info@icron.com | icron.com

